

Scala für Zeichnung der Mond-Berge .

Fig. 1.

• Verhältniß der Breite des schwarzen Strichs zur Breite des weißen Zwischenraums.

1 : 8. 2 : 7. 3 : 6. 4 : 5. 5 : 4. 6 : 3. 7 : 2. 8 : 1.

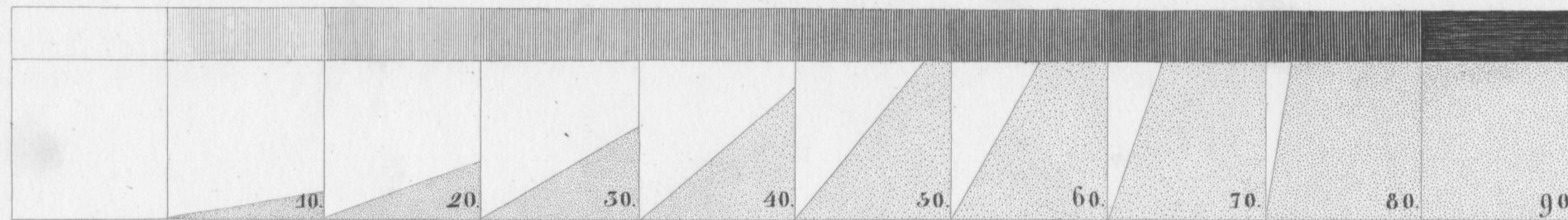

Scala für Angabe der Mond-Farbe .

Fig. 2.

Der Glanz des Aristarchus 10° die Schatten der Mond Berge 0° Helligkeit.

10° 9° 8° 7° 6° 5° 4° 3° 2° 1° 0°



Fig. 6.

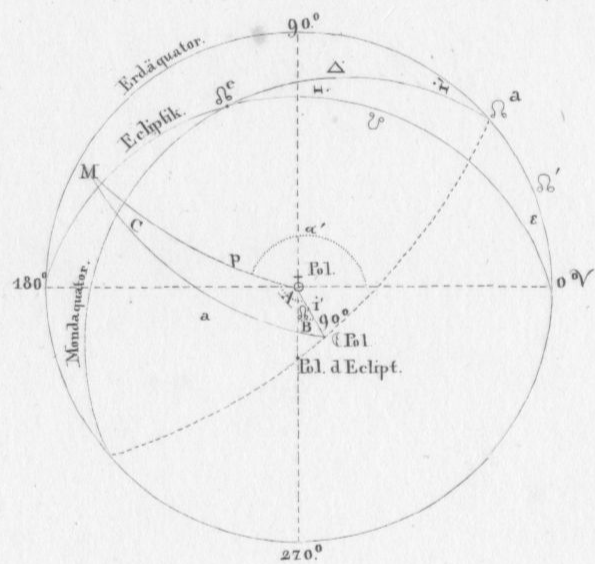

Fig. 3.

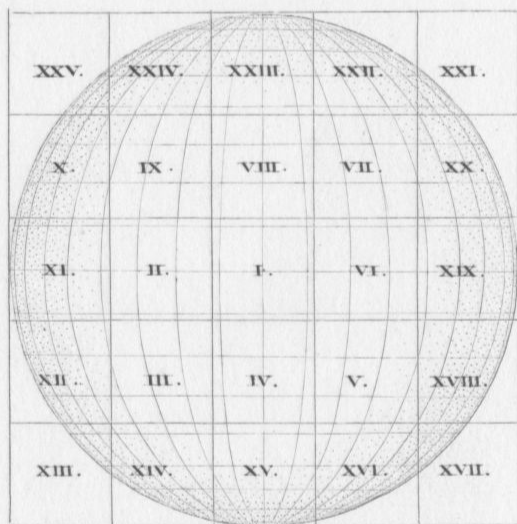

Fig. 7.

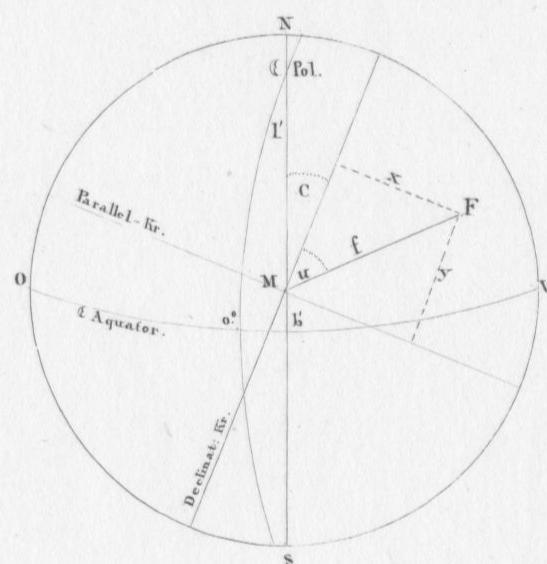

Fig. 5.

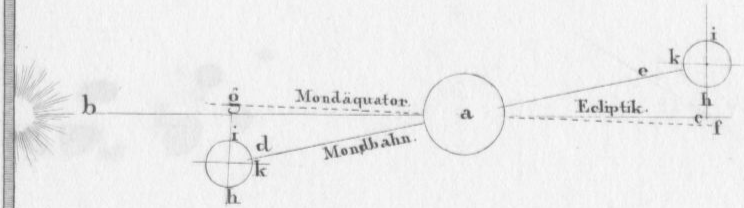

Fig. 4.

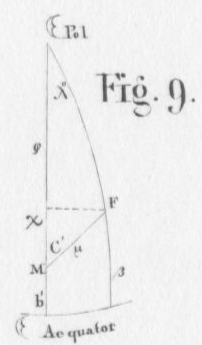
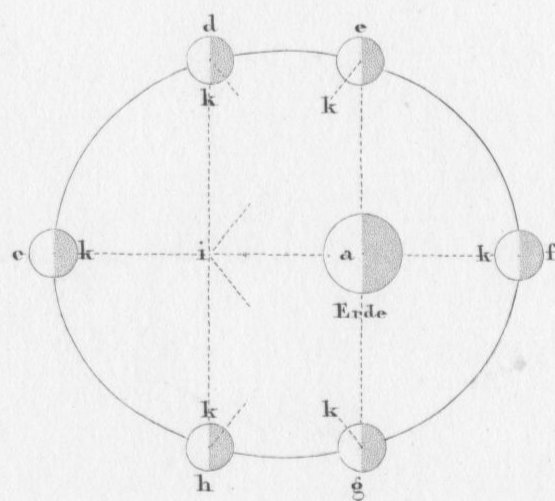

Fig. 9.

Fig. 10.

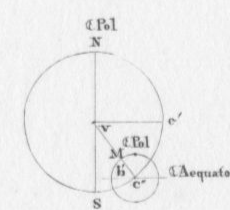

Fig. 8.

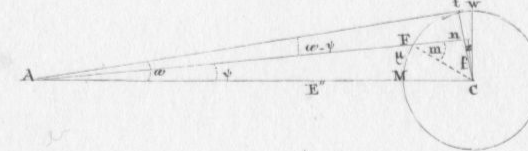



Fig: 1.

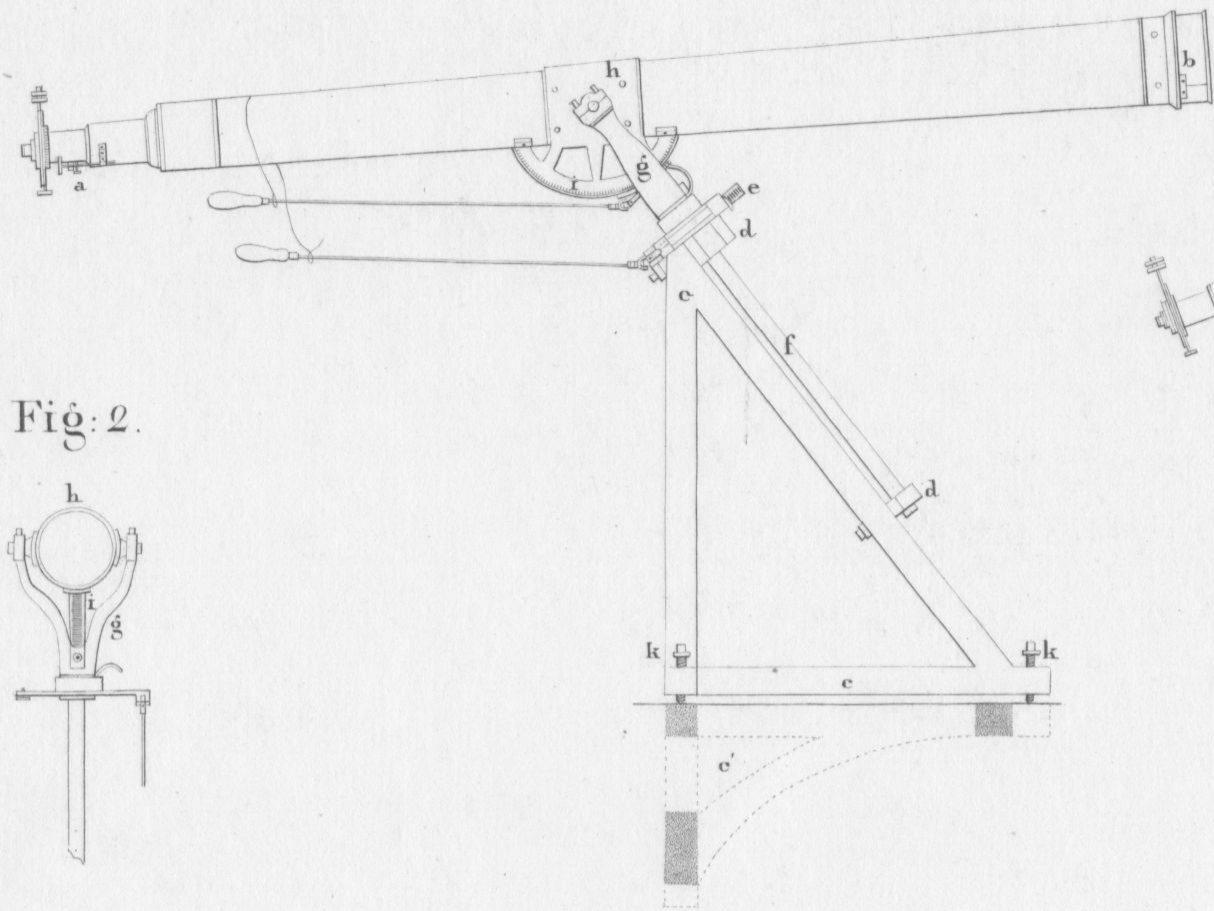

Fig: 3.

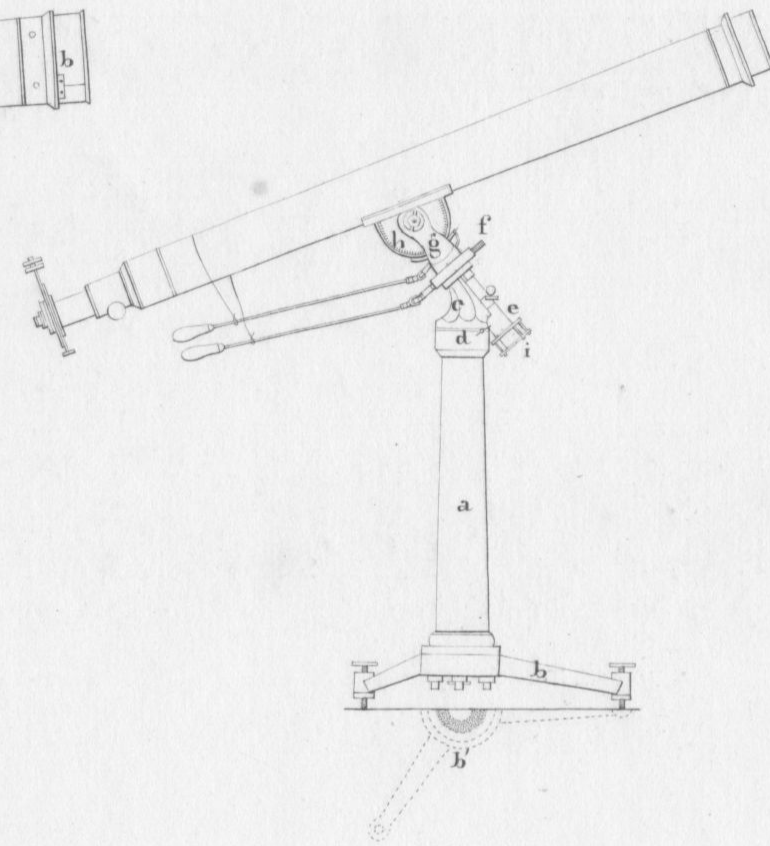

Fig: 2.

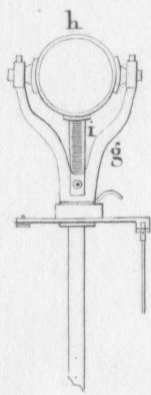

Fig: 4.

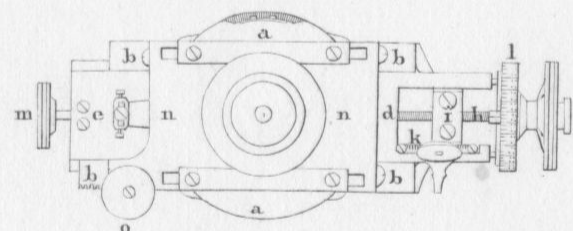

Fig: 5.

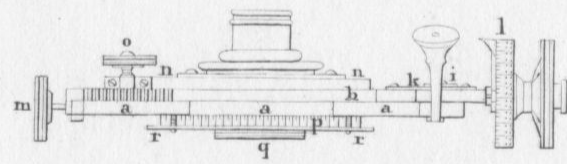

Fig: 6.

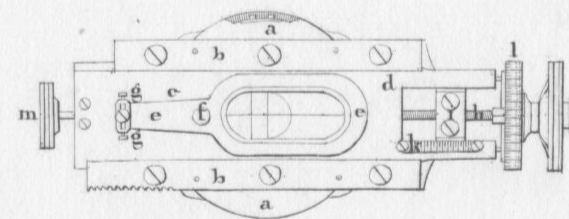

Fig: 8.

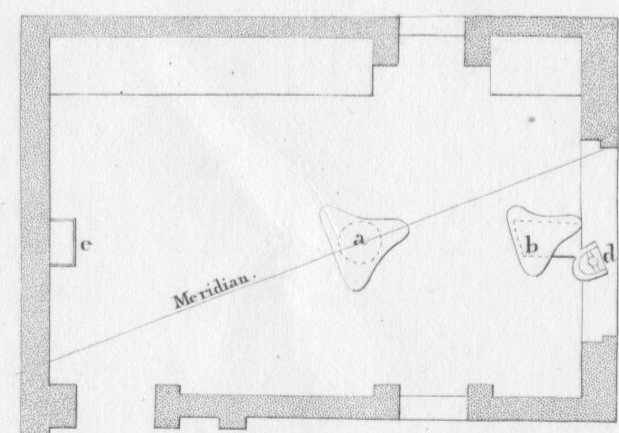

Fig: 7.

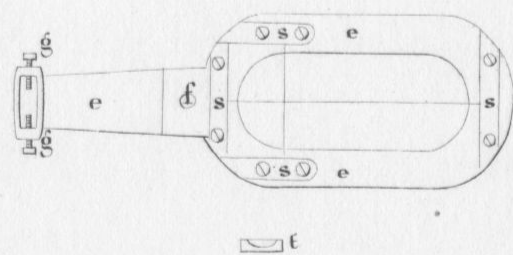
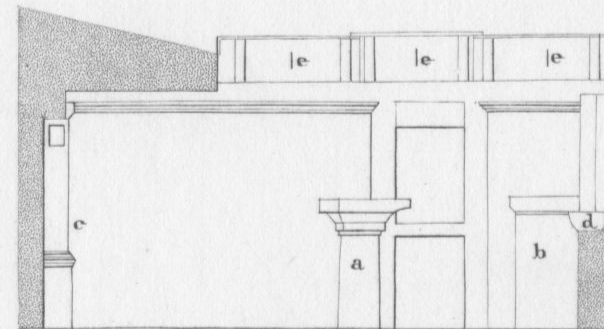

Fig: 9.



Mondcharte

Süd.

Sect. I.

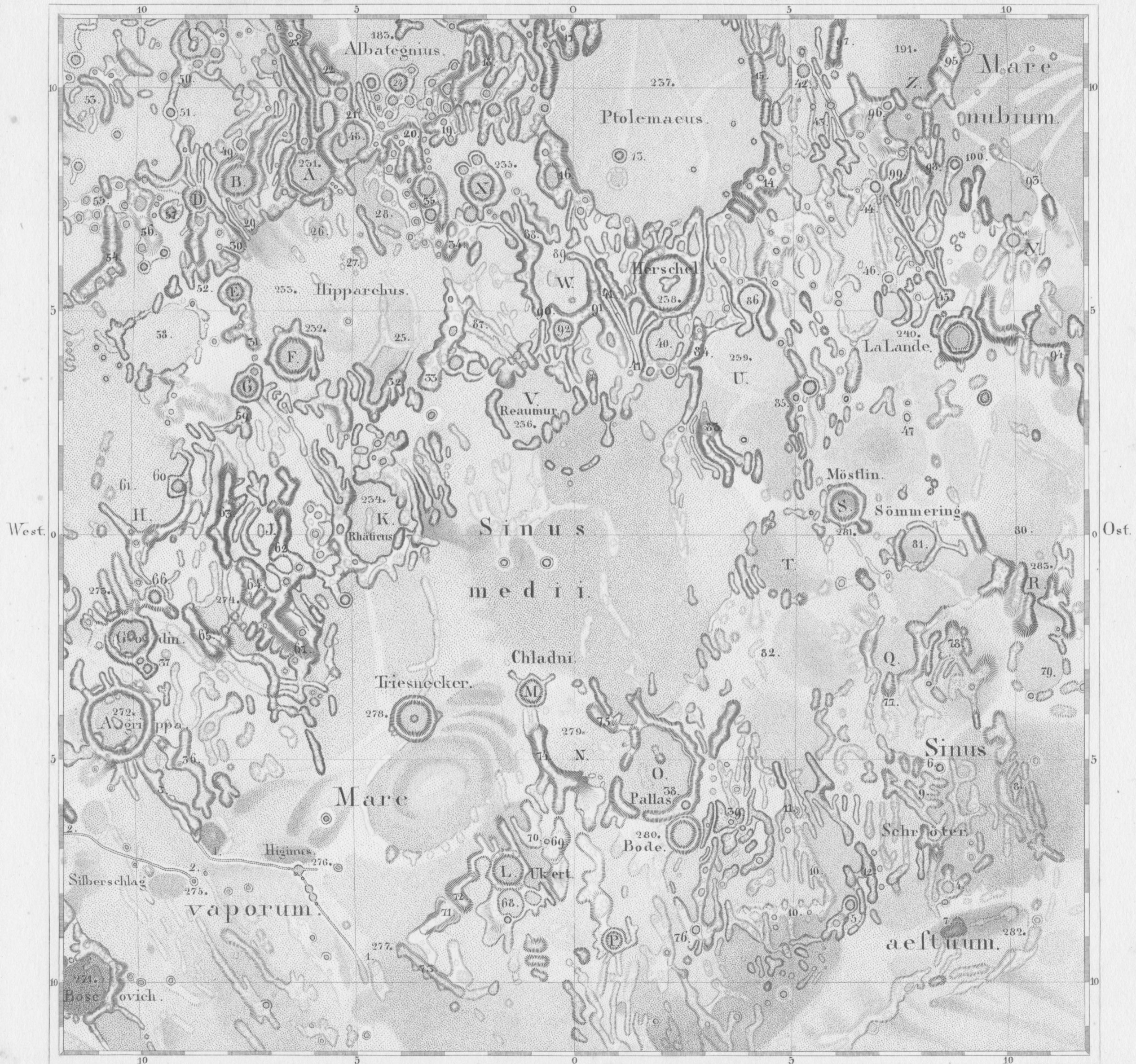

gestv. Berger unter Leitv. Krille.

Nord.

beob. u. gez. v. W. G. Lohrmann.

Mondcharte

Süd

Sect. II.



West 0

Ost 0

gest. v. G. Borger und C. Zumpfe.

Nord

beob. u. gez. von W. G. Lohmann.

Mondcharte

Sect. III.

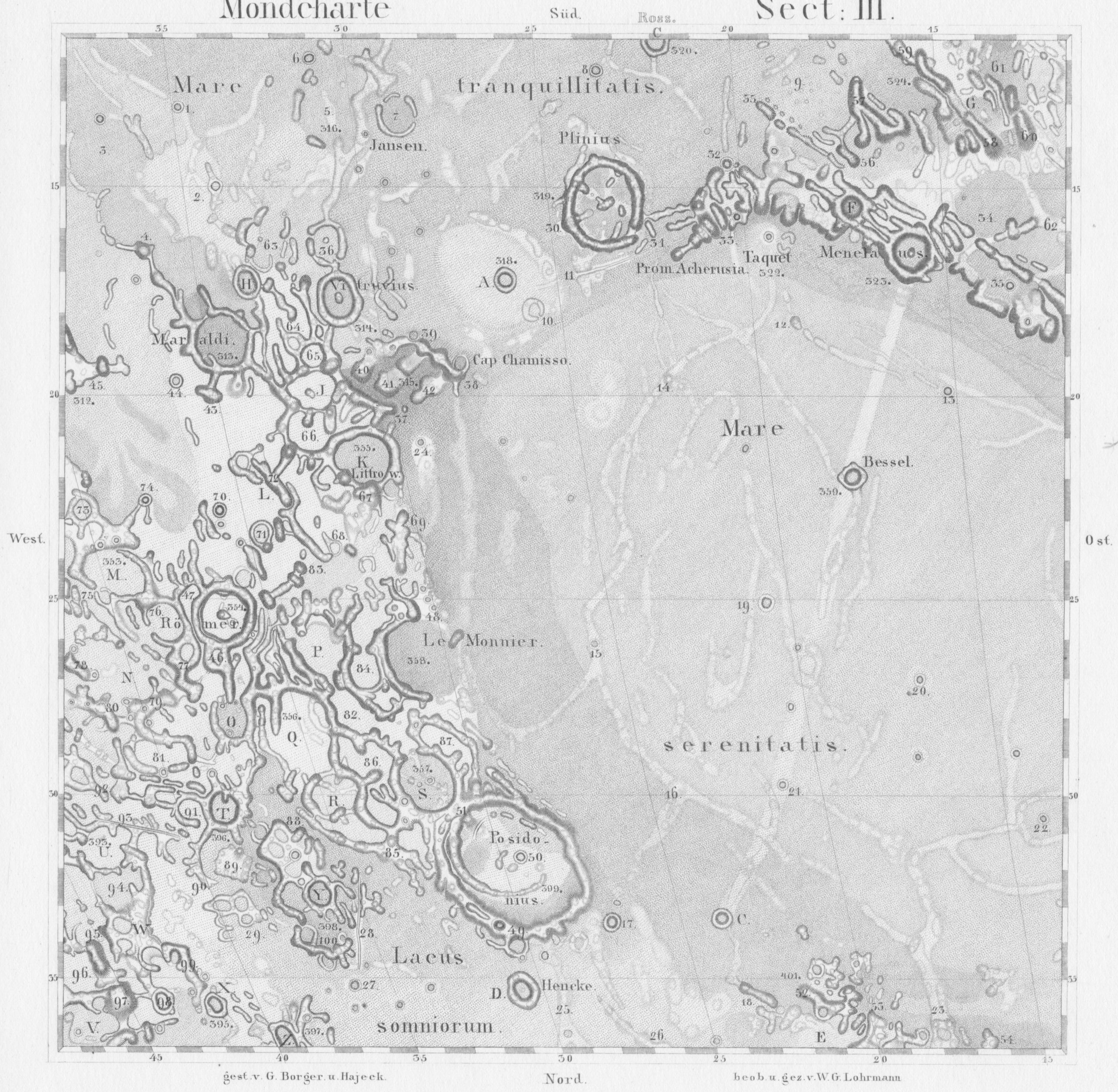

Mondcharte

Süd.

Sect: IV.



gest.v. Berger und Zumppe .

Nord.

Leob. u.gez v W.G. Lohrmann .

Mondcharte

Süd

Sect. V.

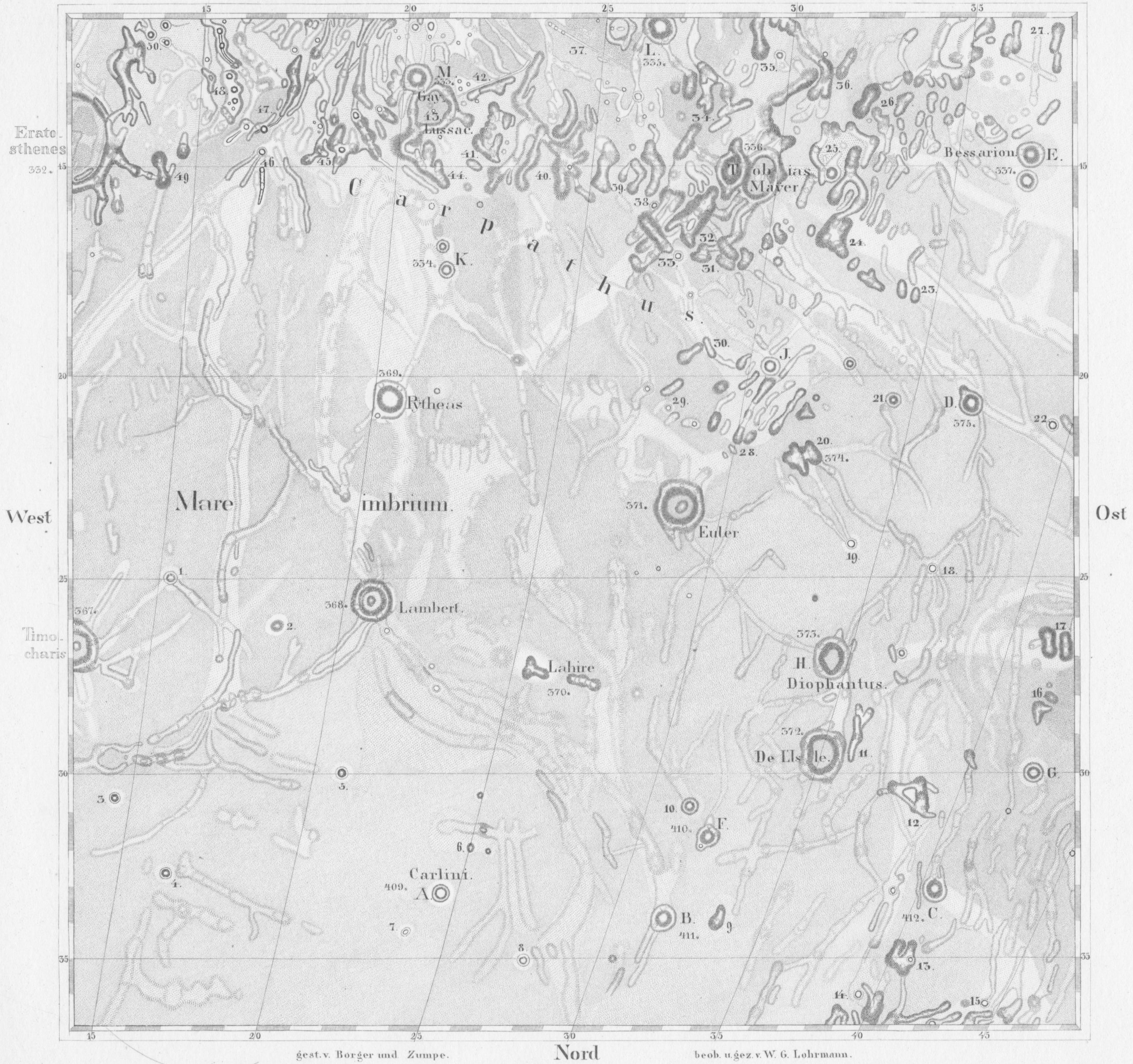

Mondcharte

Süd.

Sect. VI.

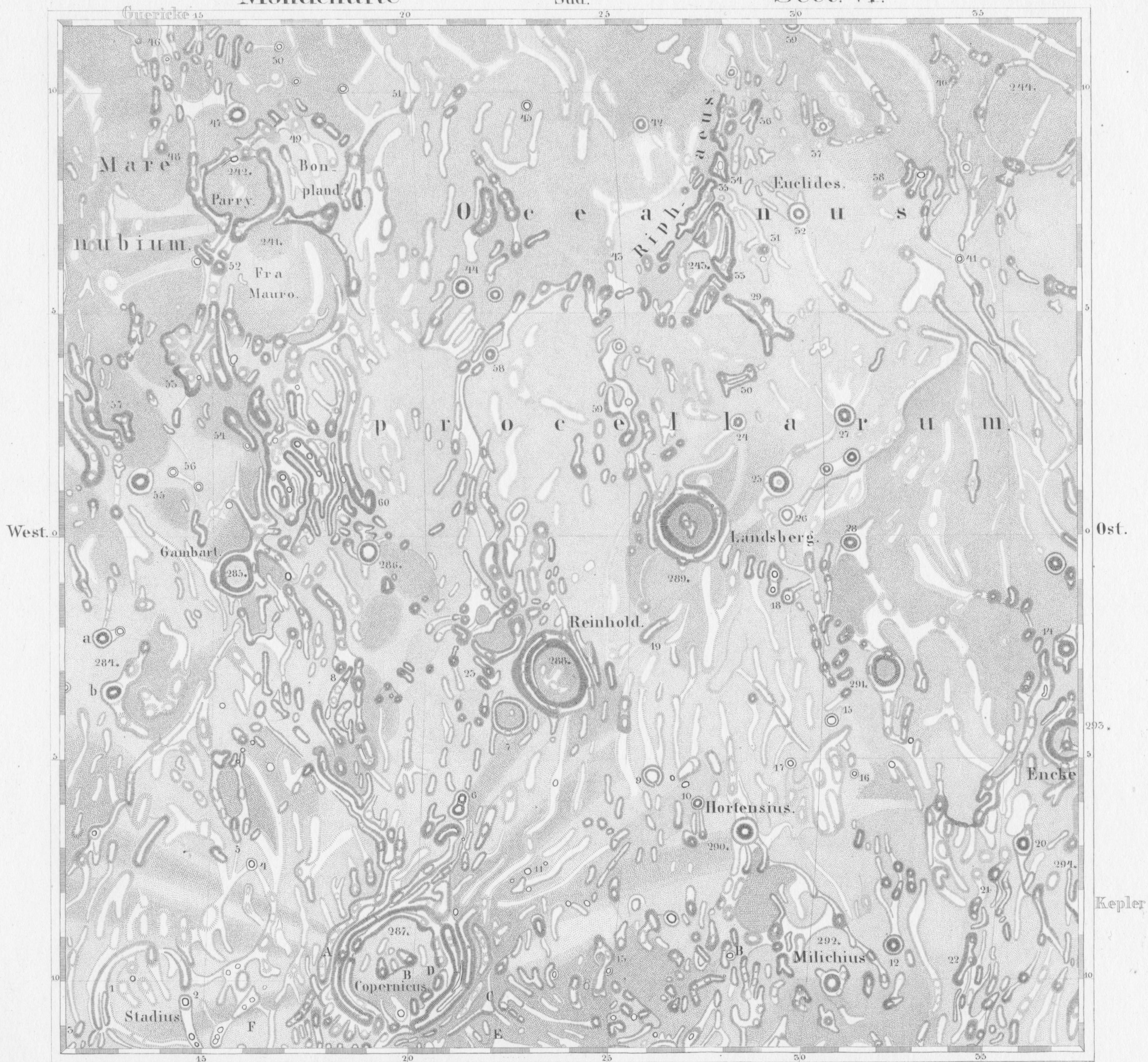

gest. v. C. Borger

Nord.

beob. u. gez. von W. G. Lohmann.



Mondcharte

Süd.

Sect. VII.

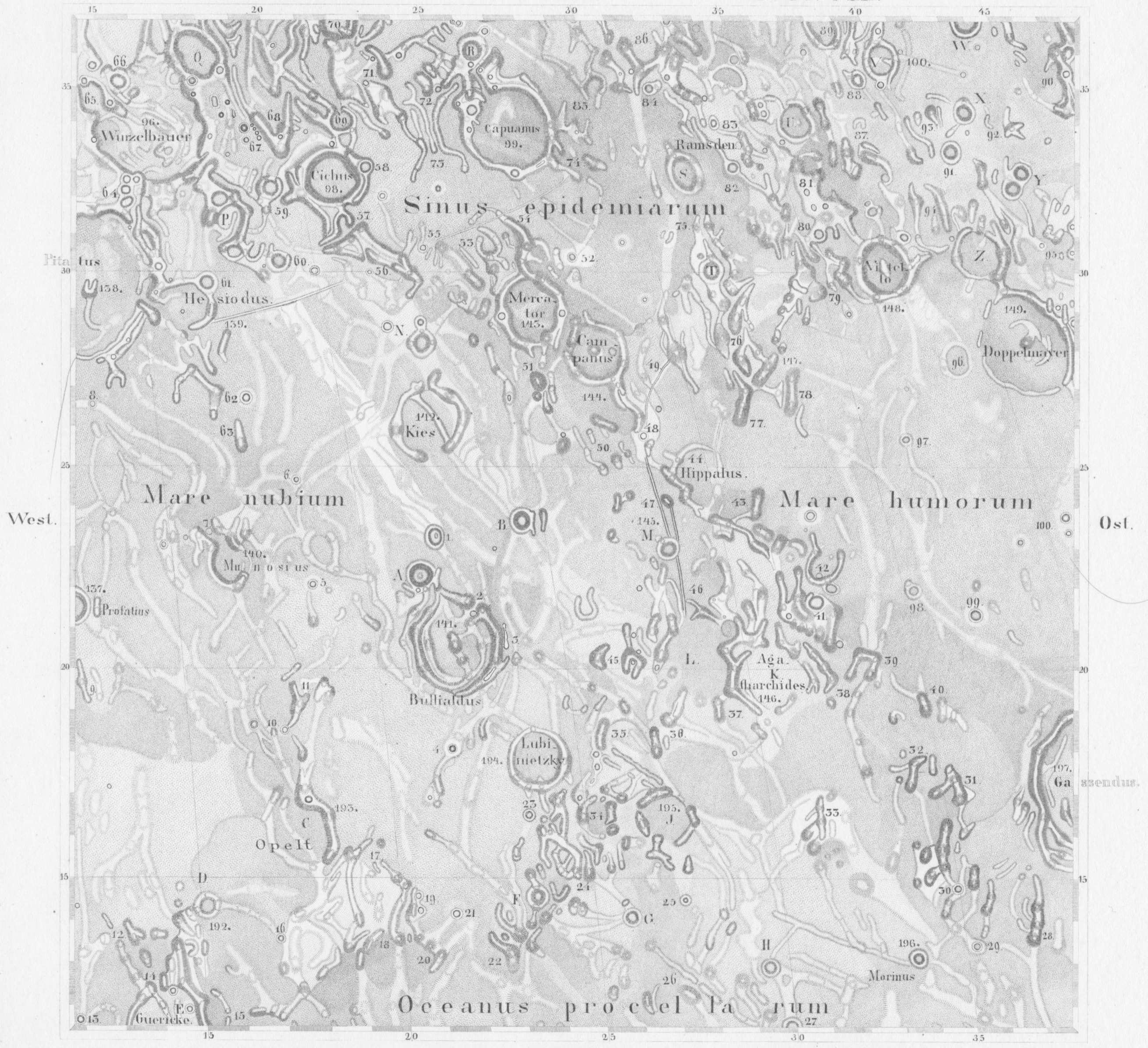

gest. v. G. Borger und G. Zampe.

Nord.

beob. u. gez. von W. G. Lohmann.

Mondcharte

Süd.

Sect. VIII.

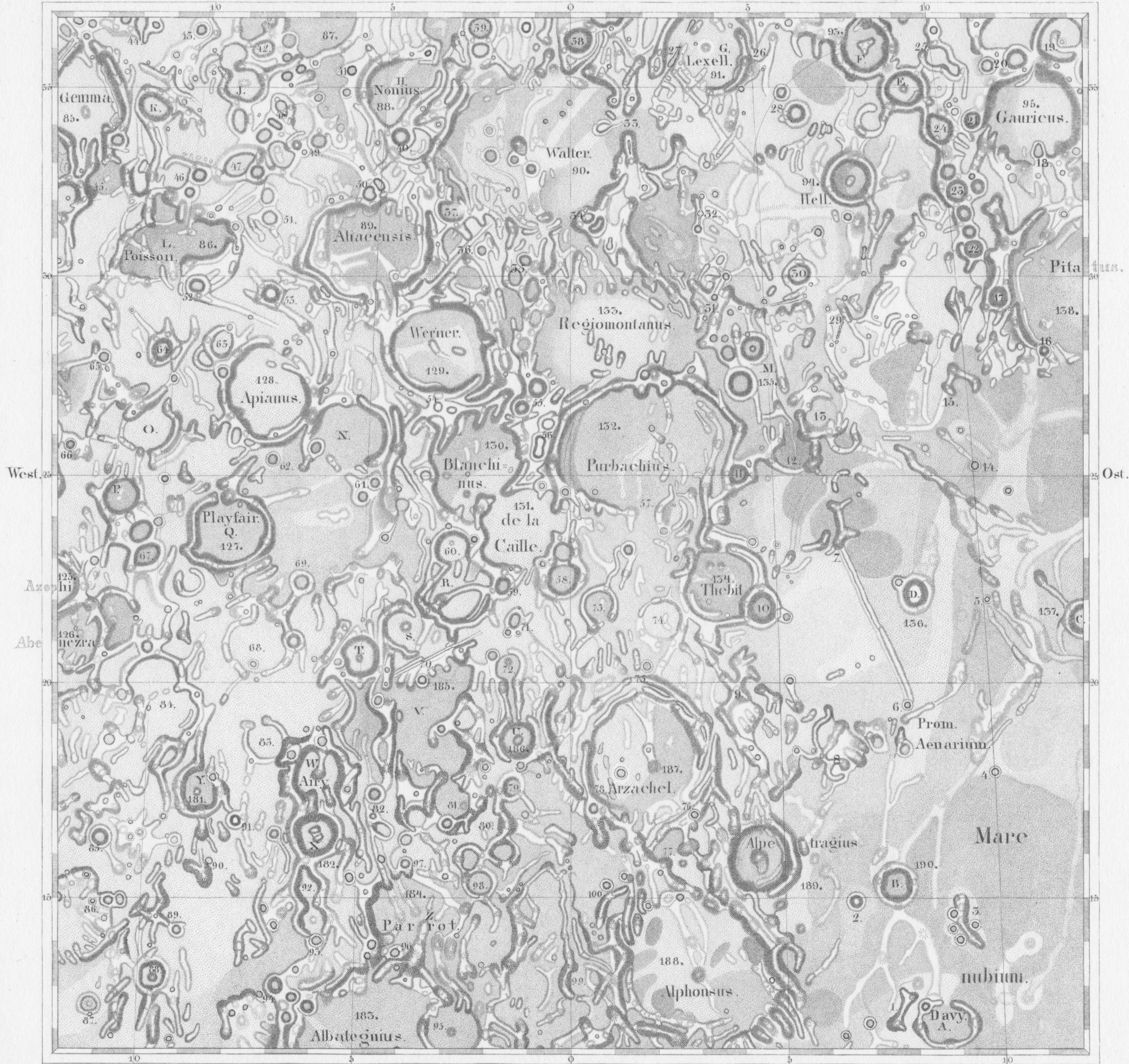

gest. v. G. Borger u. G. Zumpfe.

Nord.

beob. u. gez. von W. G. Lehmann.

Mondcharte

Süd

Seet. IX.

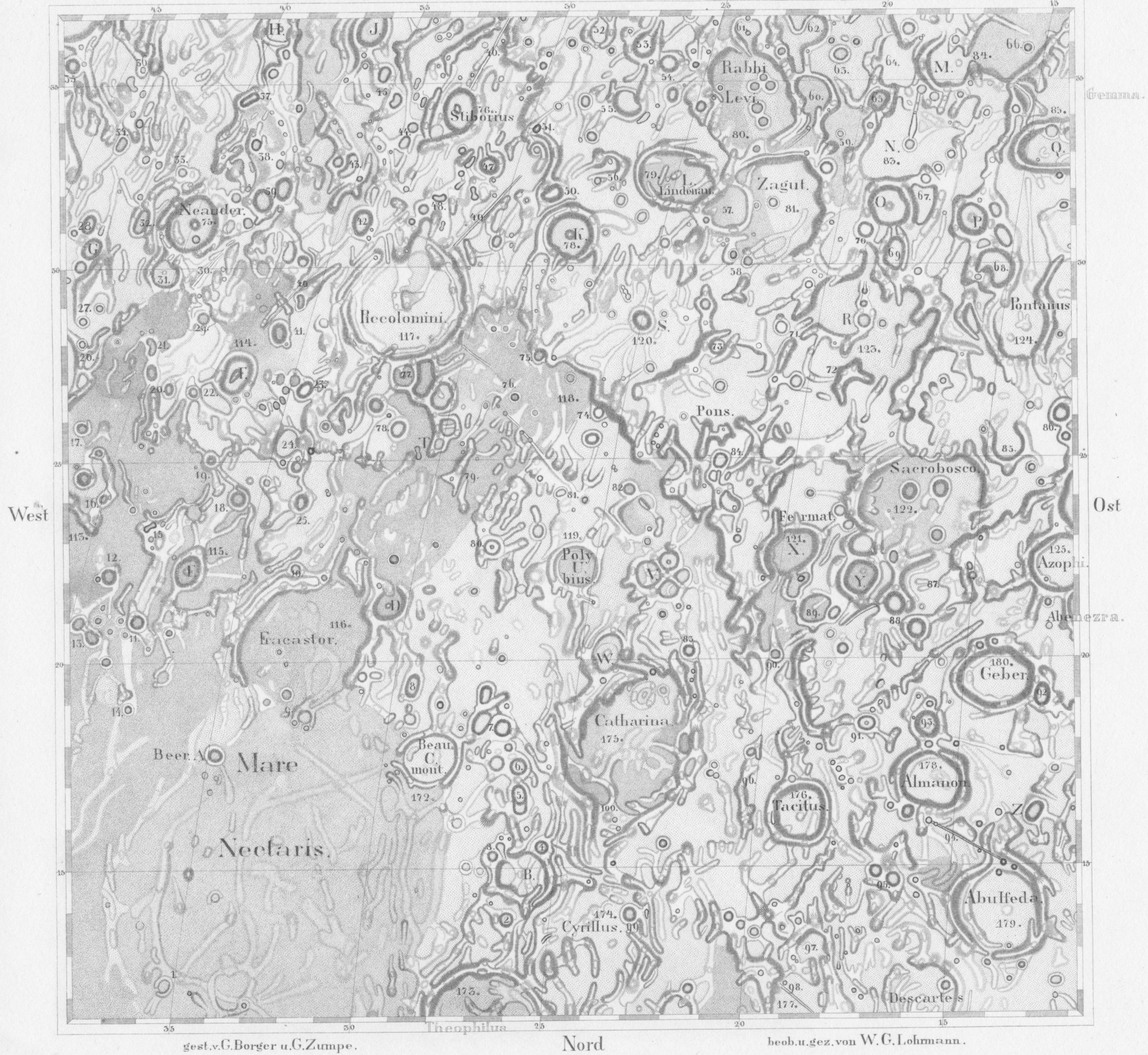

Mondcharte

Süd.

Sect. X.

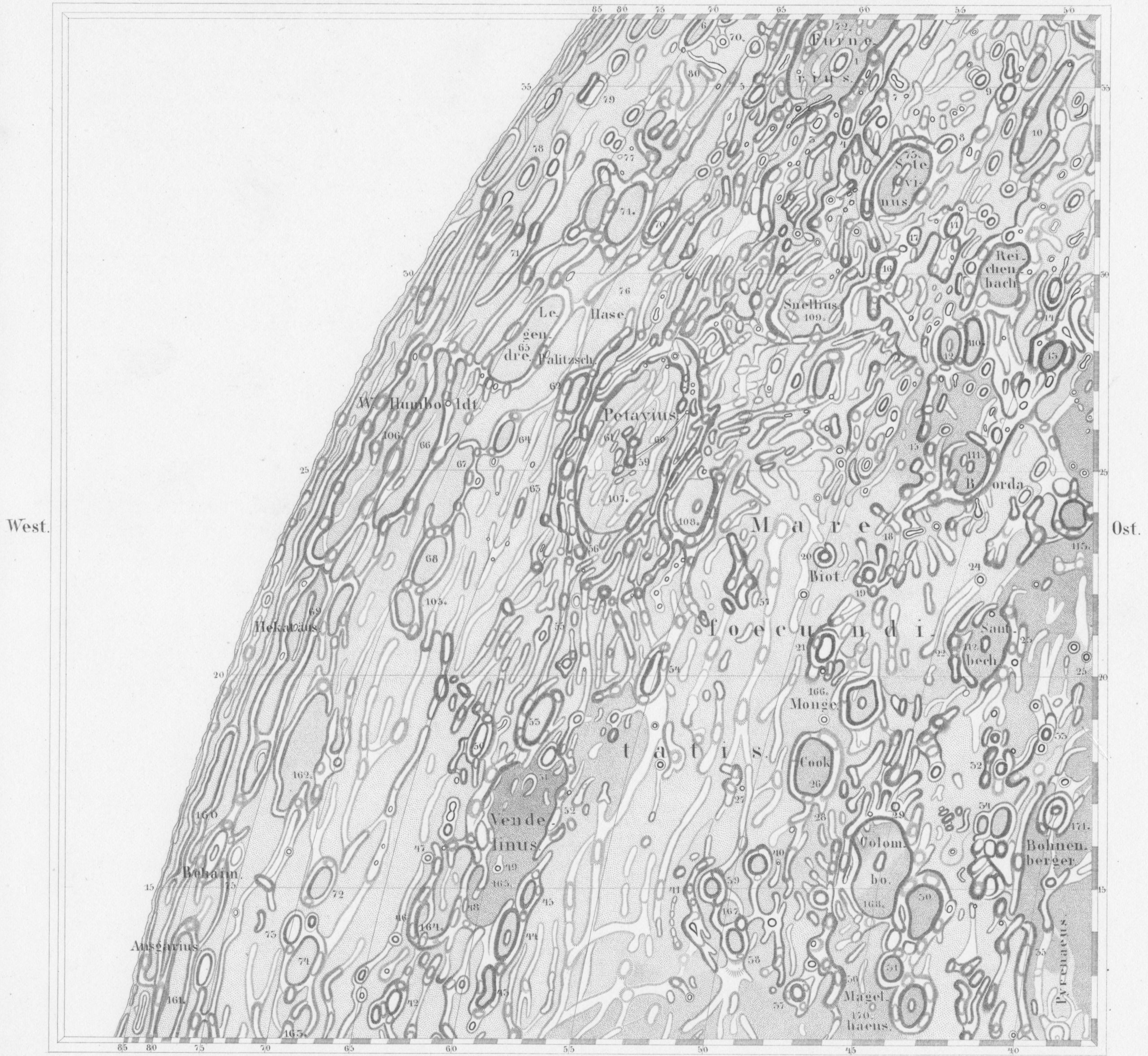

West.

Ost.

gest. v. E. Reyher u. Keyl.

Nord.

beob. u. gez. von W. G. Lohmann.

Mondcharte

Süd.

Sect. XI.

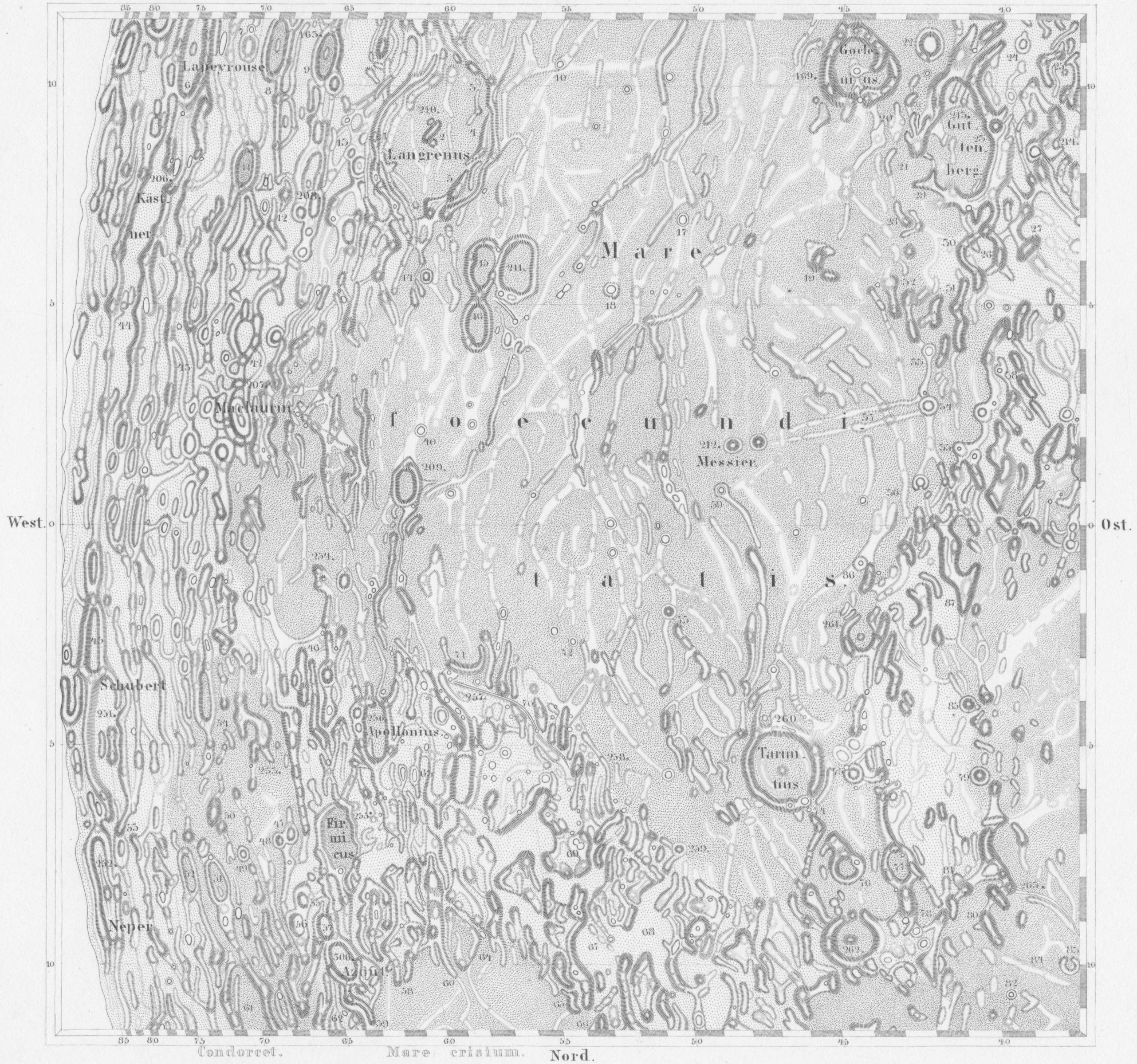

gest. v. Börger u. Reyher

beob. u. gez. von W. G. Lohrmann.

Mondcharte

Süd.

Sect. XII.

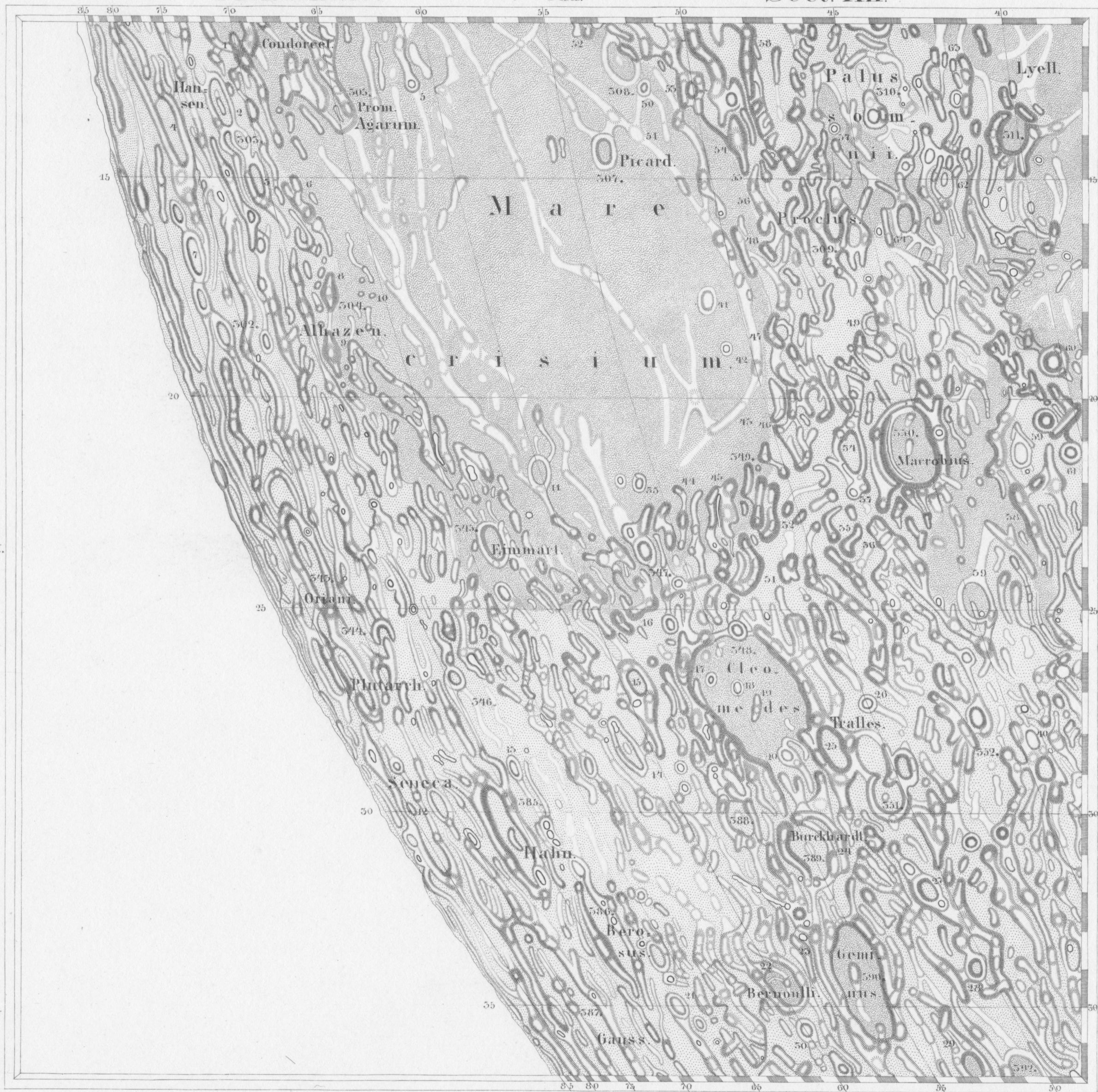

West.

Ost.

Gest. v. Borger u. F. Reyher.

Nord.

beob. u. gez. von W. G. Lohmann.

Mondcharte

Sect. XIII.



West.

Ost.

gest. v. Reyher, Lange u. Keyl.

Nord

beob. u. gez. von W. G. Lohrmann.

Mondcharte

Süd.

Sect. XIV.

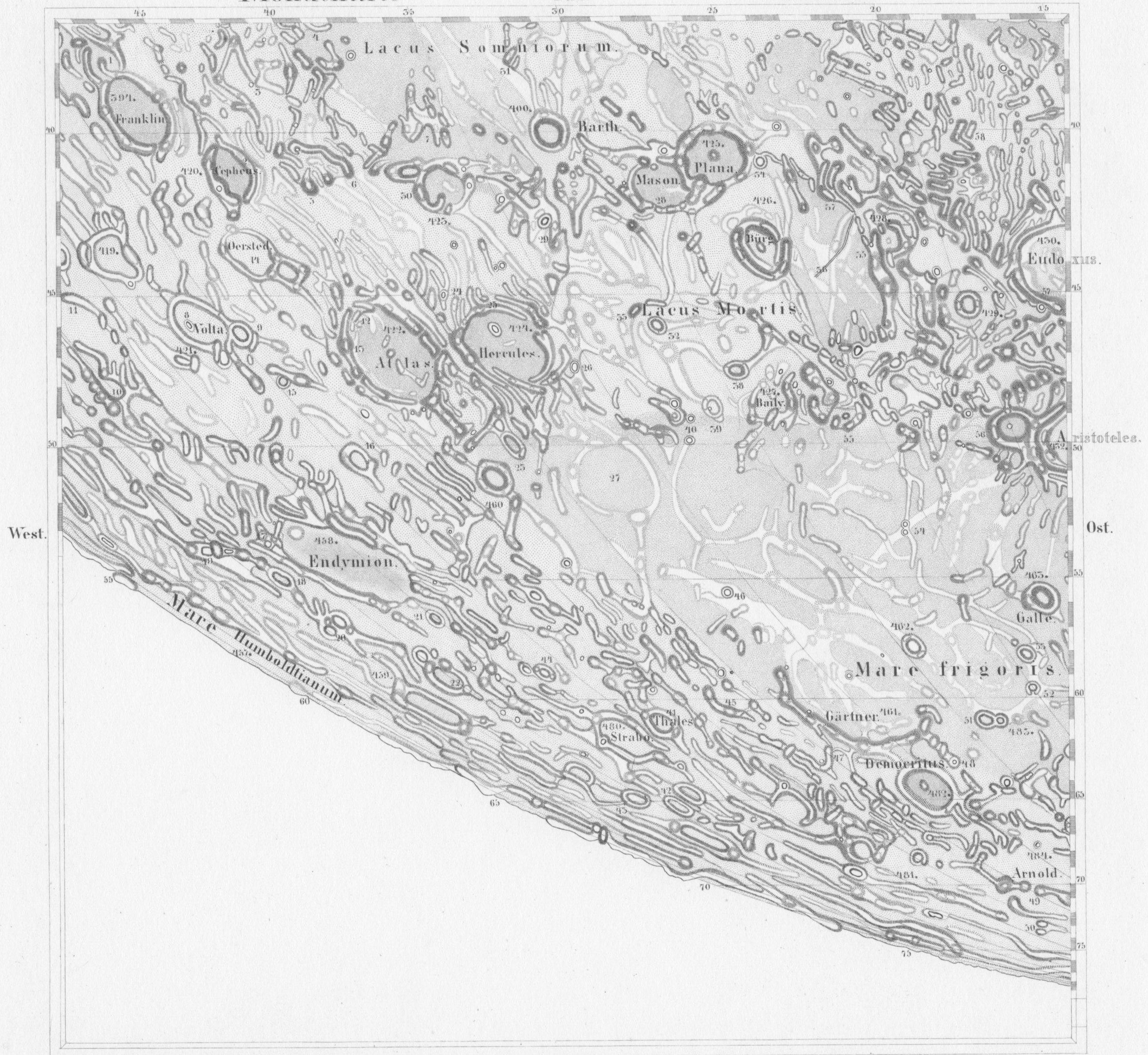

West.

Ost.

gest.v. Borger, Fischer, Lange u. Keyl.

Nord.

beob. u. gez. von W. G. Lohrmann.



Mondcharte

Süd.

Sect. XV.

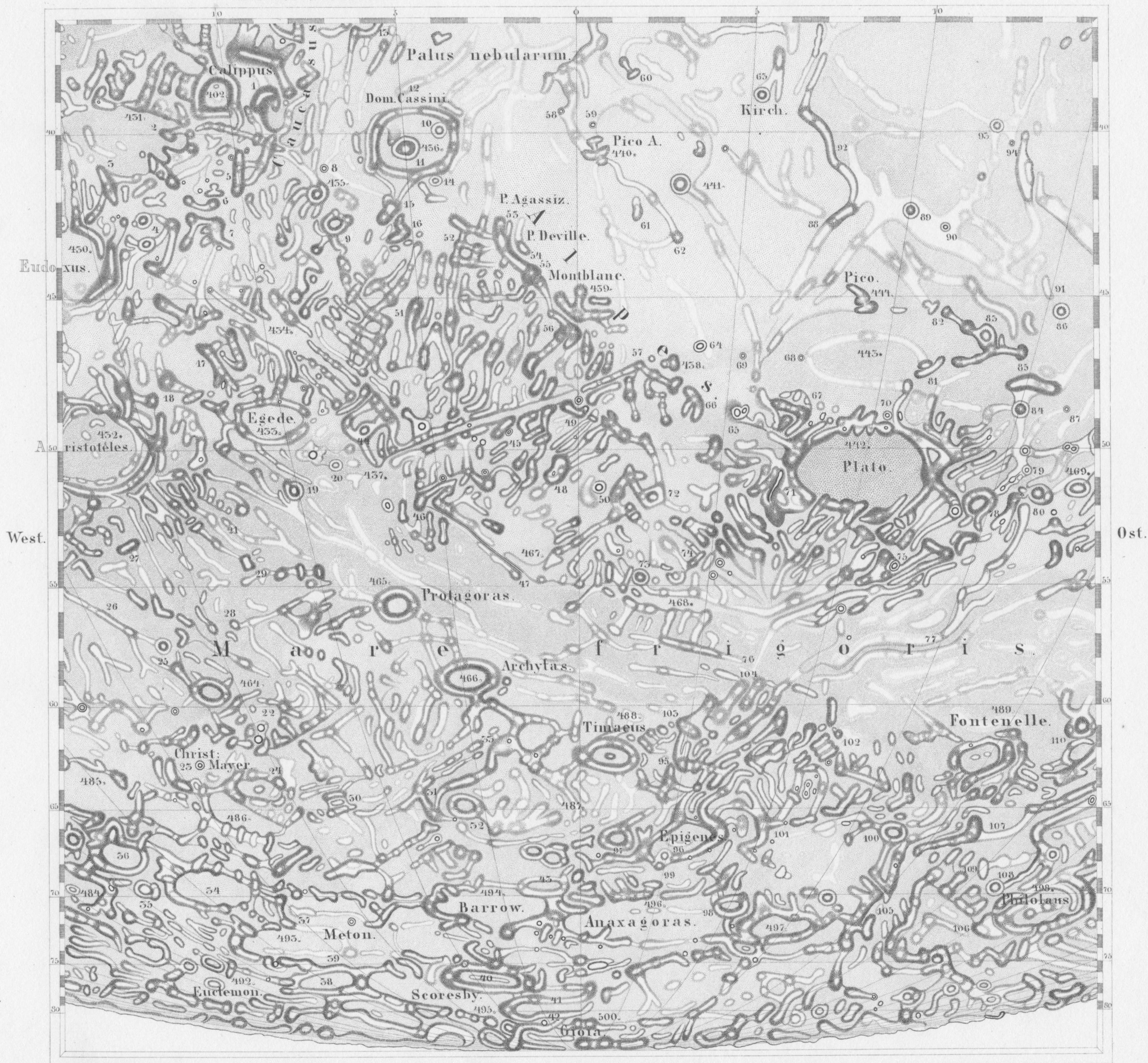

gest. v. Reyher, Lange u. Keyl.

Nord.

beob. u. gez. von W. G. Lohrmann.

Mondcharte

Süd.

Sect. XVI.



gest. v. Borger, Trendelenburg, Fischer, Lange u. Keyl.

Nord.

beob. u. gez. v. W. G. Lohrmann.

Mondcharte

Sect. XVII.



gest. v. Trendelenburg, Fischer, Lange u. Keyl.

Nord.

beob. u. gez. von W. G. Lohrmann.

Mondcharte

Marius.

Süd.

Sect. XVIII.



Mondcharte

Süd.

Sect. XIX.

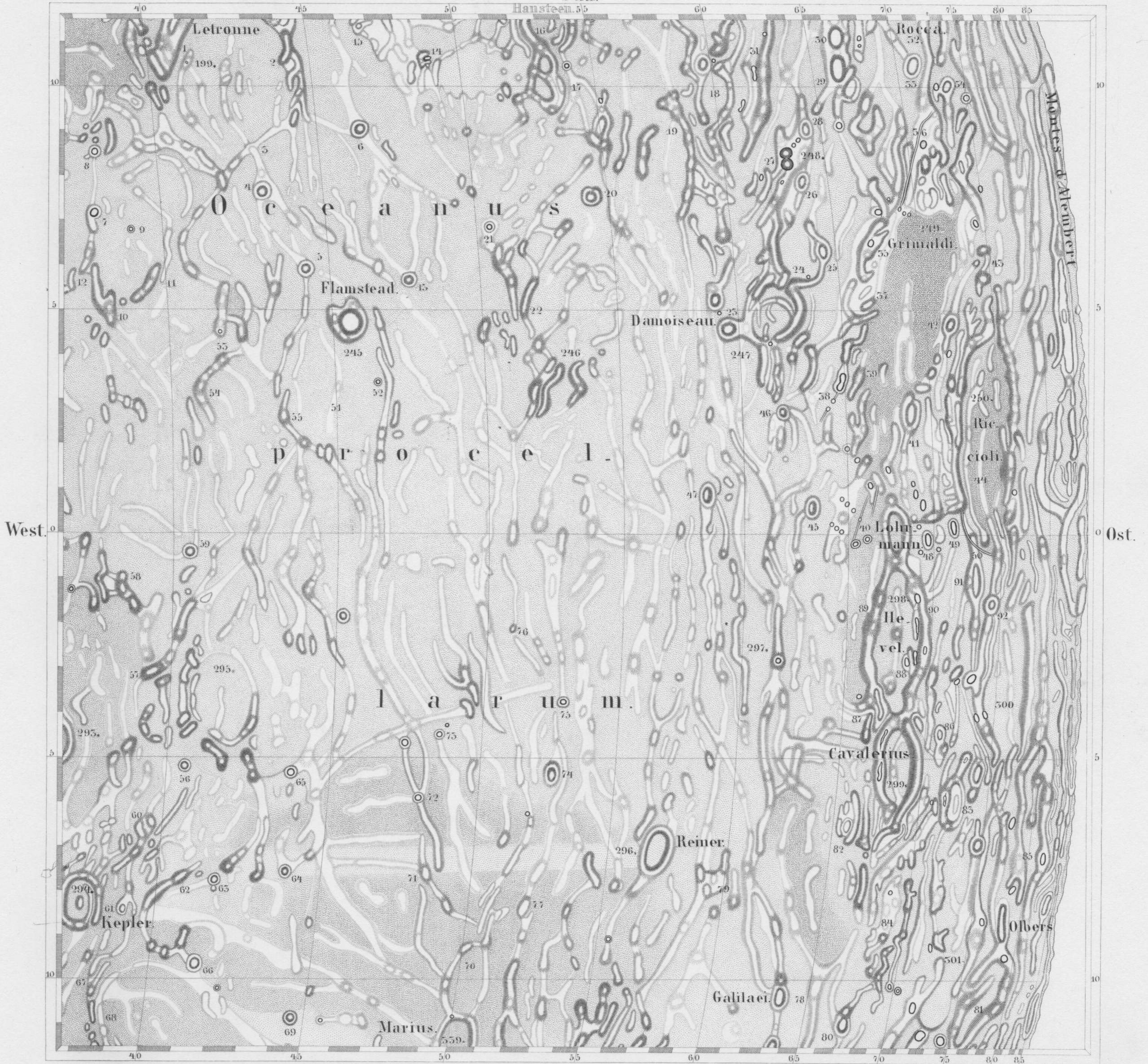

gest. v. Reyher, Fischer u. Keyl.

Nord.

beob. u. gez. von W. G. Lohrmann.

Mondcharte

Sect. XX.

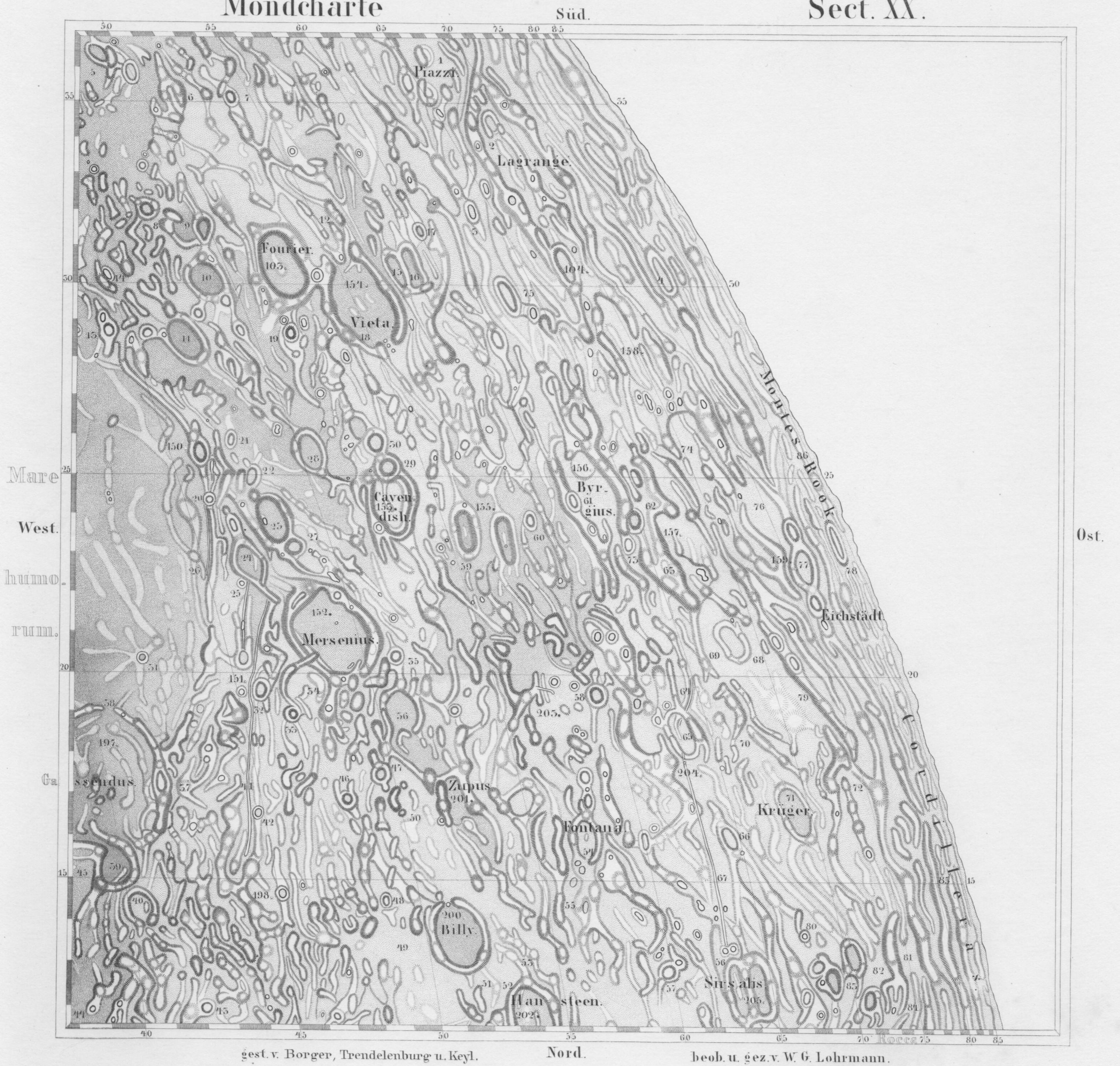

gest. v. Berger, Trendelenburg u. Keyl.

Nord.

beob. u. gez. v. W. G. Lohrmann.

Mondcharte

Süd.

Sect: XXI.

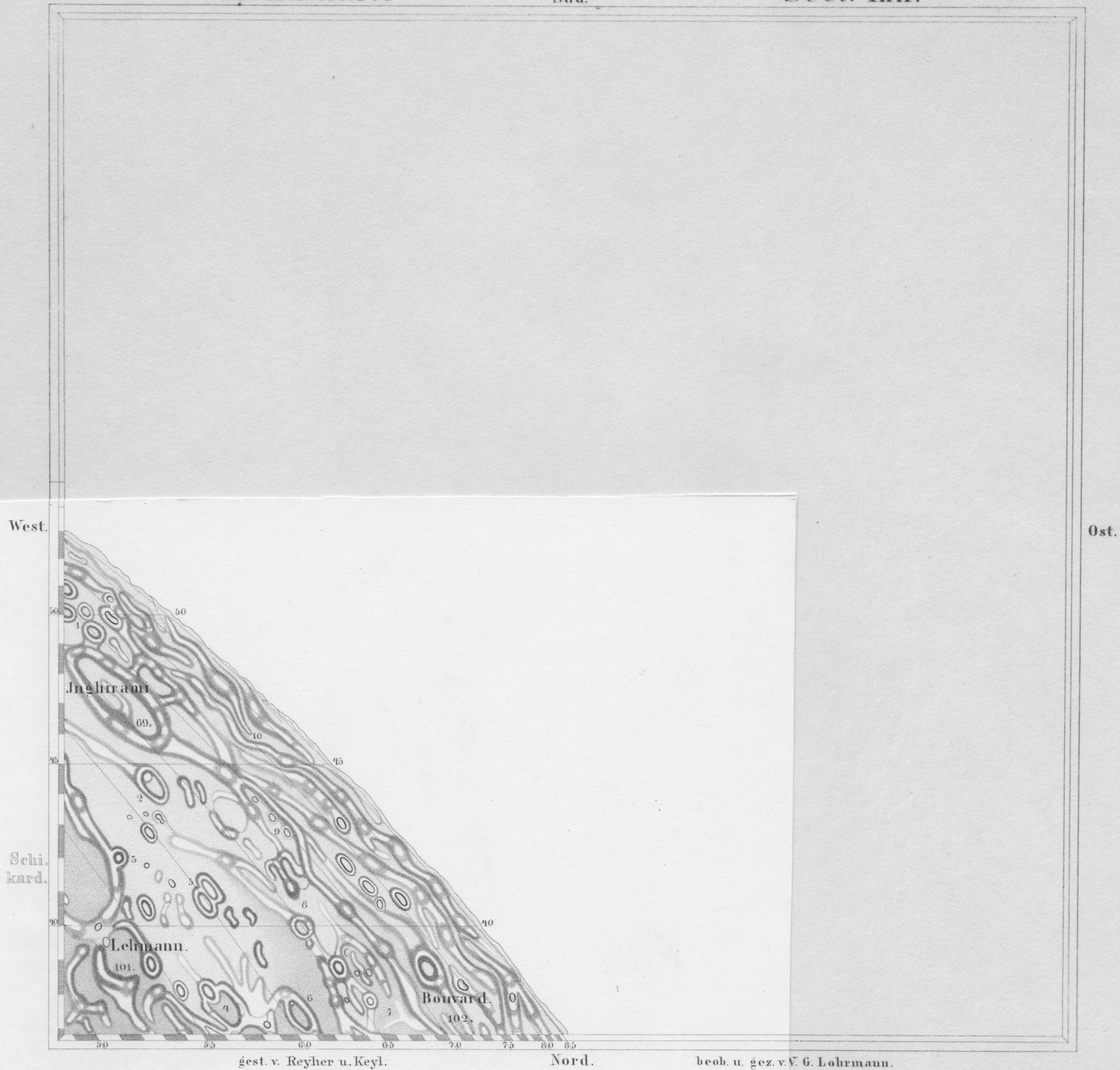

Sect: XXI

Mondcharte

Süd.

Sect: XXII.

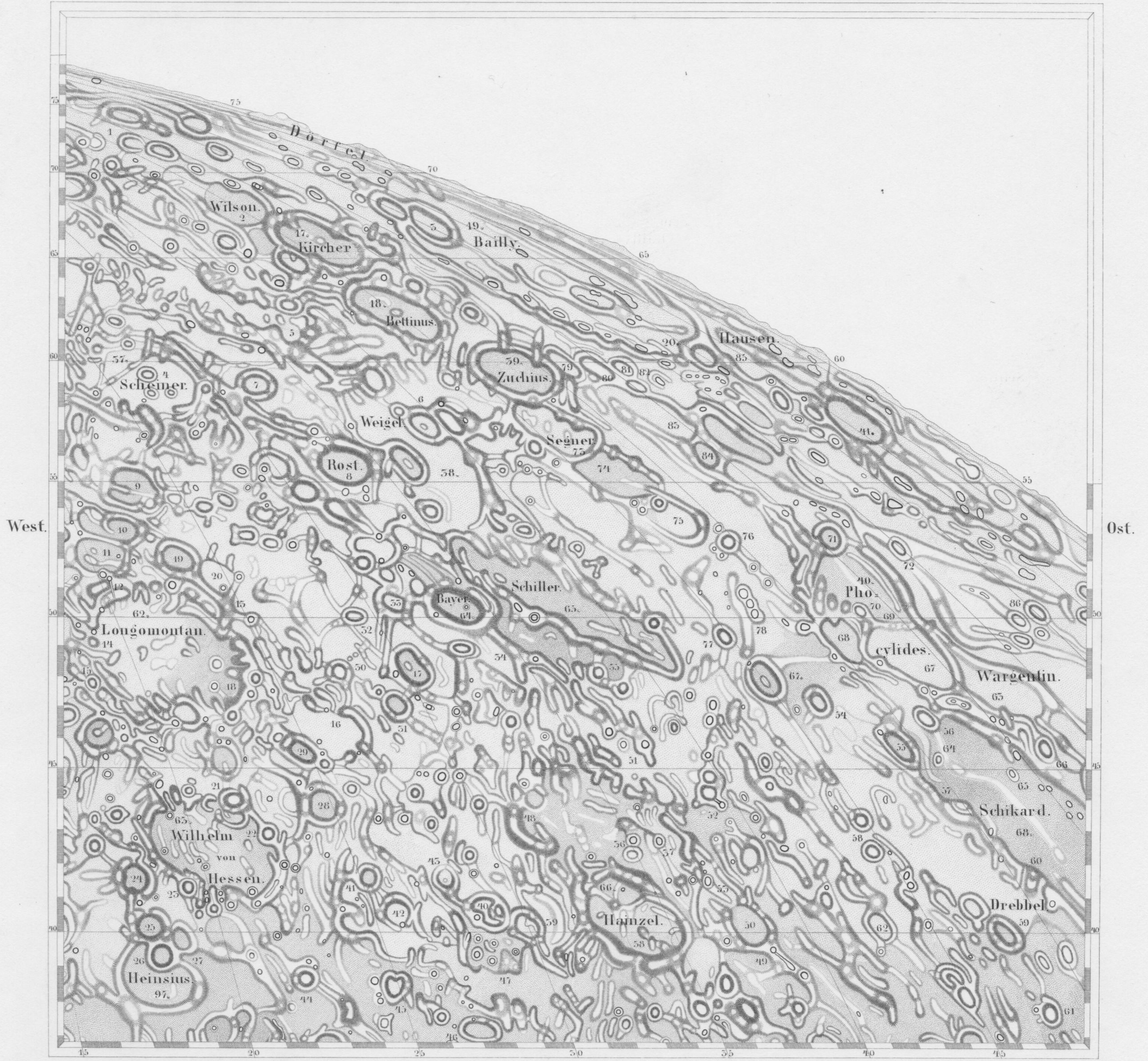

gest. v. Reyher u. Keyl.

Nord.

beob. u. gez. v. W. G. Lohrmann.



Mondcharte

Süd.

Sect: XXIII.

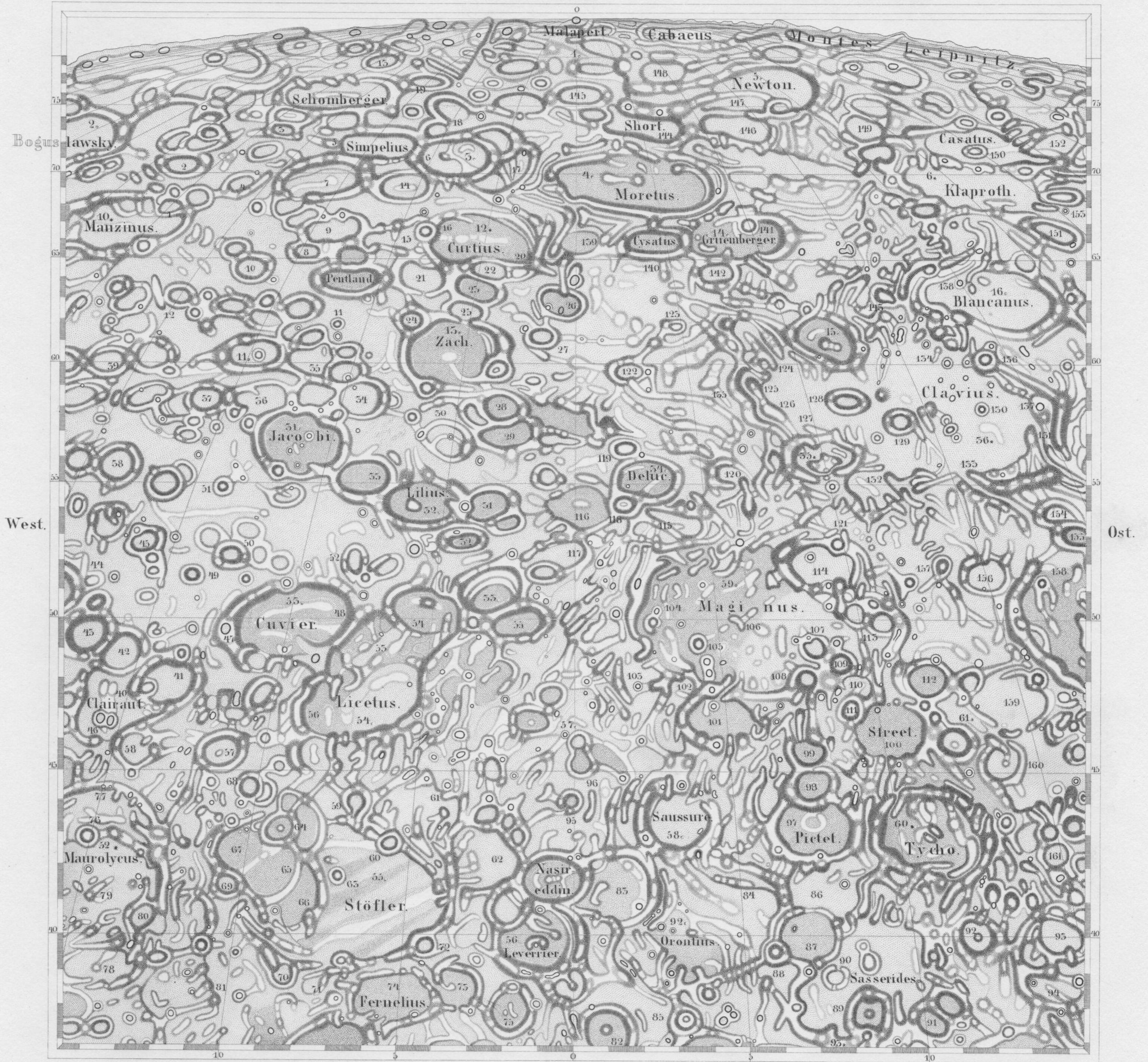

gest. v. Reyher u. Fischer.

Nord.

beob. u. gez. v. W. G. Lohmann.

Mondcharte

Süd.

Sect: XXIV.



Mondcharte

Süd.

Sect: XXV.

West.

Ost.



gest. v. F. Reyher.

Nord.

beob. u. gez. v. W. Lohrmann.

Rheita.